

Terra™ PIV

Diode pumped Nd:YLF laser

Terra PIV is a dual oscillator/single head, high repetition rate, diode-pumped Nd:YLF laser. The Terra PIV offers the ultimate in flexibility for PIV and other dual output applications.

The combination of two independent oscillators allows complete control of pulse separation and pulse energy. Both oscillators in the Terra PIV system are identical in optical design giving temporally and spatially matched pulses for the highest degree of cross-correlation. Each oscillator can be independently triggered via TTL inputs. As an option, a compact, external combination box can be directly attached to the laser to provide for an easy and safe access to the beam combination optics.

The Terra PIV uses our proprietary intracavity frequency doubling to achieve high energy 527 nm outputs without resorting to the tight focusing (which can result in optical damage) necessary for extra-cavity doubling. Our proprietary pump chamber design increases the overall efficiency allowing for high pulse energy, excellent beam quality and long component lifetimes from a compact and robust diode-pumped package.

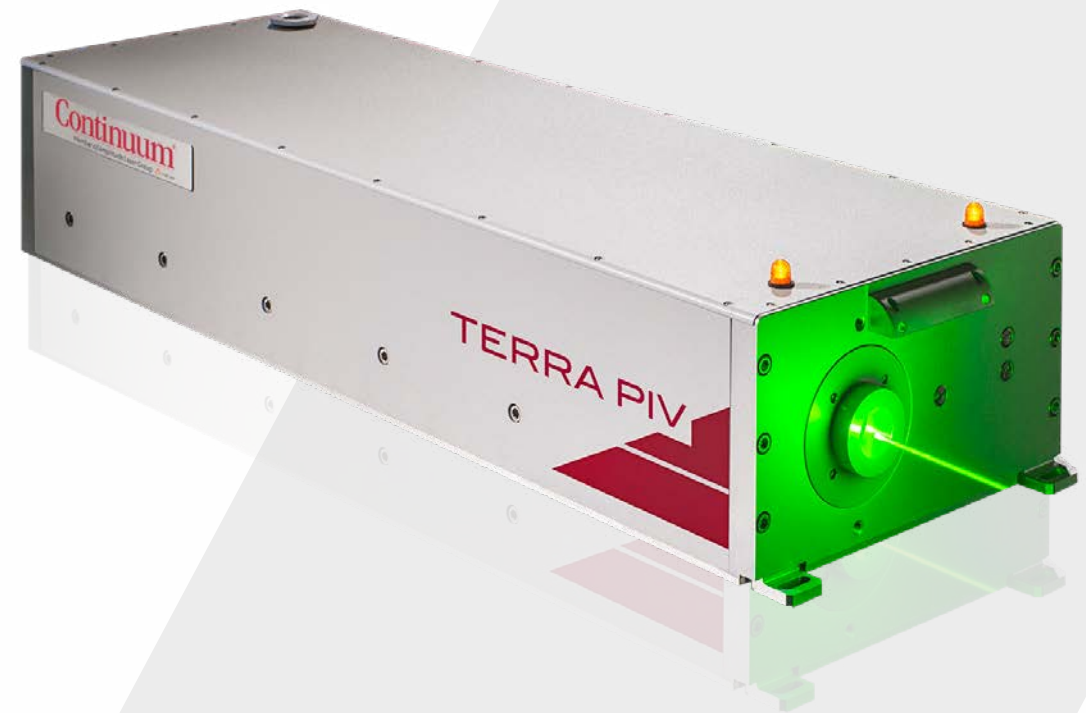

Applications

Industry:

- > Stent/Glass/PCB/Fine Metal Cutting
- > LCD/Solar Edge Deletion
- > Marking
- > Wafer Trimming
- > Micro-hole Drilling
- > Ceramics Scribing
- > Fine Wire Stripping
- > Diamond/Gemstone Processing

Science:

- > Ti:Sapphire pumping
- > Particle Image Velocimetry (PIV)
- > Combustion Analysis
- > Laser Induced Fluorescence
- > LIDAR
- > Resonance Raman Spectroscopy
- > Chemical Analysis of Macromolecules
- > Laser Microprobe Analysis

Key Features

- > >60 mJ total energy at 1 kHz
- > Average power >100 W @ 3 kHz
- > Ideal for Particle Image Velocimetry
- > Independent external trigger for each oscillator
- > External and internal triggering
- > Built-in optics for beam combination
- > Record 3 min. diode module replacement
- > Proprietary optical cavity design for optimal laser performance
- > Flexible time delay and energy adjustment

Specifications¹

527-100-M **527-80-M** **527-60-M** **527-40-M**

| | | | | |
|--|----------|-------|-------|-------|
| Wavelength (nm) | 527 | | | |
| Energy per Oscillator at 0.1-1 kHz (mJ) | 30 | 25 | 20 | 15 |
| Total Pulse Energy at 0.1-1 kHz (mJ) | 60 | 50 | 40 | 30 |
| Pulse Repetition Rate (kHz) ² | 0.1-10 | | | |
| Average Power @ 3 kHz (W) | 100 | 80 | 60 | 40 |
| Pulsewidth (ns) | < 210 | < 230 | < 250 | < 270 |
| Pulse-to-Pulse Stability (% RMS) | < 0.5 | | | |
| Beam Pointing Stability (μrad) | < 25 | | | |
| Beam Diameter at Output (mm) ^{3, 4} | 3.0 | | | |
| Beam Quality (M ²) | < 25 | | | |
| Beam Divergence (mrad) ⁴ | 8 | | | |
| Time Jitter (ns RMS) | < 3 | | | |
| Polarization ⁵ | Circular | | | |

¹ All specifications at 1kHz unless otherwise noted.
² Single shot to 0.1 kHz available with external trigger
³ Typical measurement (±10%)
⁴ Measured at 13.5% level at output window
⁵ Cross-polarization available as option

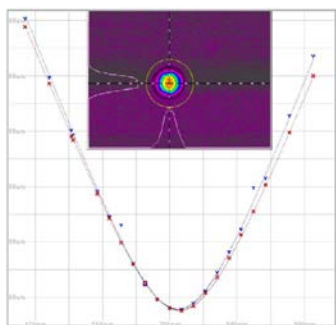

Terra PIV Output Profile
 Smooth beam profile, ideal for PIV applications.

Dimensions

| | |
|----------------------|--|
| Optical Head (LxWxH) | 812 x 254 x 145 mm (31.9 x 10.0 x 5.6 in) |
| Power Supply (LxWxH) | 509 x 483 x 221 mm (20.0 x 19.0 x 8.7 in) |
| Chiller (LxWxH) | 699 x 483 x 492 mm (27.5 x 19.0 x 19.4 in) |

Weight

| | |
|--------------|------------------|
| Optical Head | 31.5 kg (70 lbs) |
| Power Supply | 27 kg (60 lbs) |
| Chiller | 65 kg (144 lbs) |

Electrical Service

| | |
|--------------|---|
| Power Supply | Single-phase: 200-240 VAC, 50/60 Hz operating current: 10A, max current: 20A |
| Chiller | Single-phase: 230 ±10% VAC, 20A, 50/60 Hz operating current: 12A, max current: 20A |

Temperature & Humidity

| | |
|-----------------------|-----------------------|
| Operating Temperature | 15 to 35° C |
| Storage Temperature | -20C to 50° C |
| Relative Humidity | 8-80%, non-condensing |

Control Interface

| | |
|------------------|--|
| Serial Interface | RS-232 |
| Rear Connections | External beam enable, external trigger |
| Control Software | MS Windows-based Laser Commander |

Others

| | |
|------------------|---|
| Umbilical Length | 3.65 m (12.0 ft); longer available upon request |
| Cooling | Air-water; water-water cooling option available |

Terra PIV Physical Layout

All dimensions are in inches [mm].

Top View
Optical Head

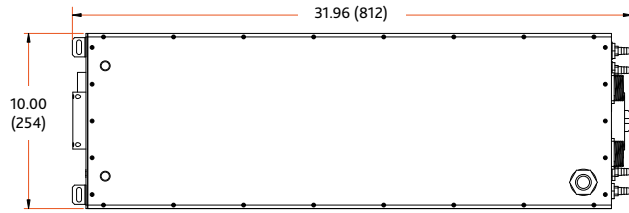

Front View

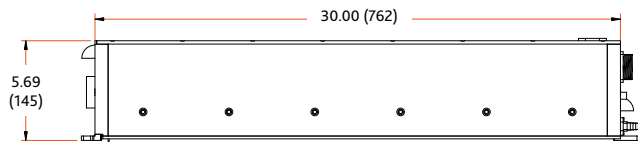
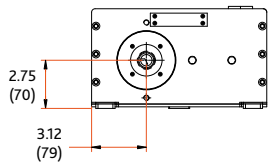

Side View

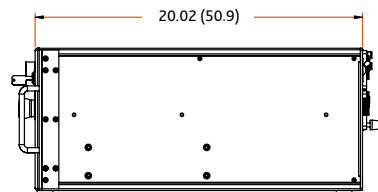
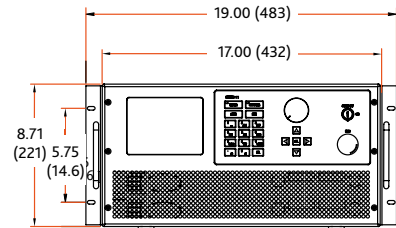

Side View
Power Supply

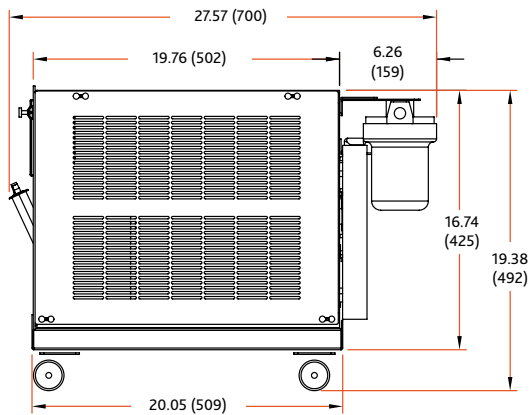
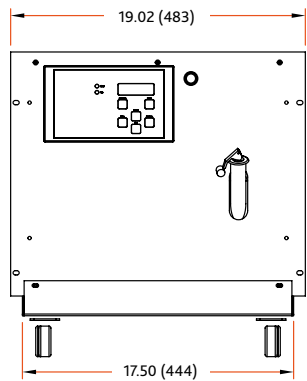

Front View
Chiller

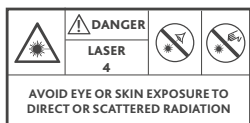

Advantages

Generation of Pulse Pairs

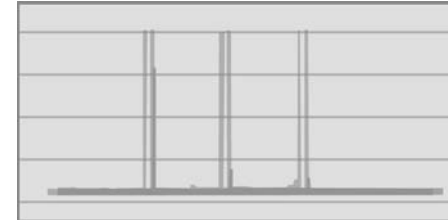

Generation of Pulse Pairs
Flexible time delay adjustment

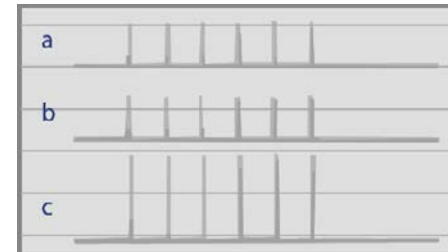

Two laser output synchronized to double the pulse energy and peak power,
a) one laser output,
b) a second laser output, and
c) combined output.

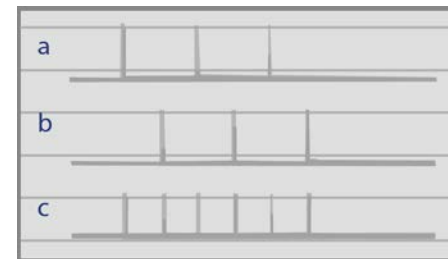

Two laser output combined with an adjustable delay to double the repetition rate of the pulse.
a) one laser output,
b) a second laser output with delay, and
c) combined laser output.

Terra™ PIV

Diode pumped Nd:YLF laser

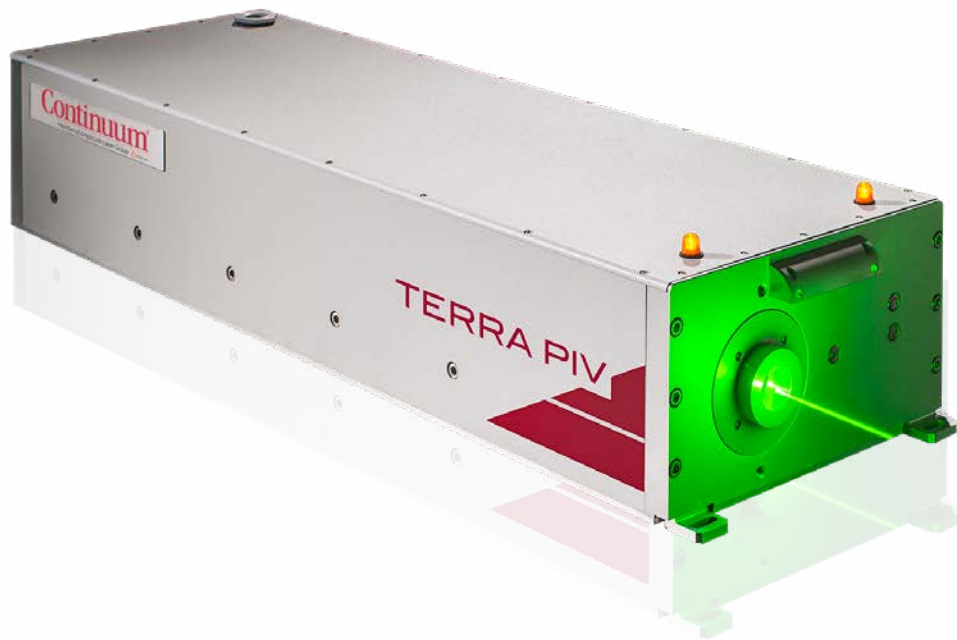

Continuum®
Member of Amplitude Laser Group 