

Terra™ HP

Diode pumped Nd:YLF laser

The Terra Nd:YLF laser is the smallest laser in its class. It produces high average power (>75 W) at kilohertz repetition rates.

Our proprietary intracavity frequency doubling results in high conversion efficiency, without resorting to the tight focusing in the doubling crystal, which is normally necessary in an extracavity design and leads to possible optical damage.

Our proprietary pump chamber design further increases the system's overall efficiency. High pulse energy, and small jitter are all available in this extremely compact and highly ruggedized package, optimized for pumping Ti:Sapphire amplifiers.

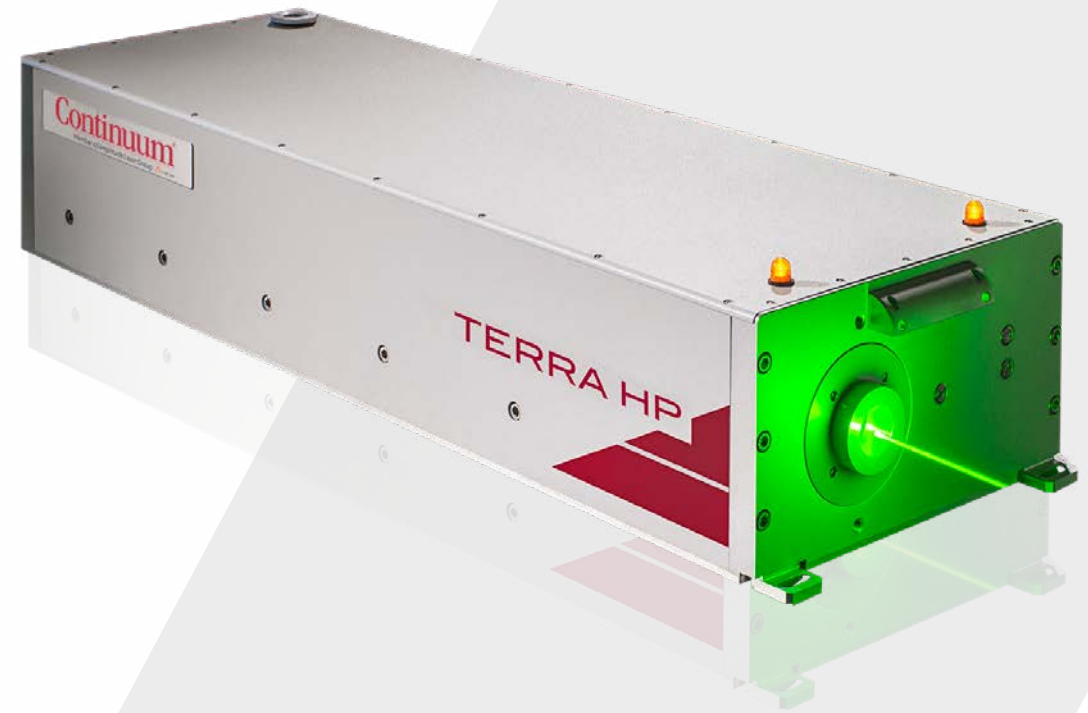

Applications

Industry:

- > Stent/Glass/PCB/Fine Metal Cutting
- > LCD/Solar Edge Deletion
- > Marking
- > Wafer Trimming
- > Micro-hole Drilling
- > Ceramics Scribing
- > Fine Wire Stripping
- > Diamond/Gemstone Processing

Science:

- > Ti:Sapphire pumping
- > Particle Image Velocimetry (PIV)
- > Combustion Analysis
- > Laser Induced Fluorescence
- > LIDAR
- > Resonance Raman Spectroscopy
- > Chemical Analysis of Macromolecules
- > Laser Microprobe Analysis

Key Features

- > Average power >75 W @ 3 kHz
- > Repetition rates up to 10 kHz
- > Exceptional beam pointing and power stability
- > Compact, rugged & hermetically sealed laser head
- > Quick & easy diode module replacement (3min)
- > Proprietary pump chamber design for optimal beam quality
- > Optimized for ultrafast amplifier pumping

Specifications¹

527-100-M

Wavelength (nm)	527
Pulse Energy at 3 kHz (mJ)	25
Pulse Repetition Rate (kHz) ²	0.1 - 10
Average Power @ 3 kHz (W)	75
Pulsewidth (ns)	190 ± 35
Energy Stability (% RMS)	< 0.5
Beam Pointing Stability (µrad)	< 25
Beam Diameter at Output (mm) ^{3,4}	3.0
Beam Quality (M ²)	> 20
Beam Divergence (mrad) ³	< 10
Time Jitter (ns RMS)	< 3
Polarization (Vertical/Horizontal)	Horizontal

¹ All specifications at 3 kHz unless otherwise noted
² Single shot to 0.1 kHz available with external trigger
³ Typical measurement (±10%)
⁴ Measured at 13.5% level at output window

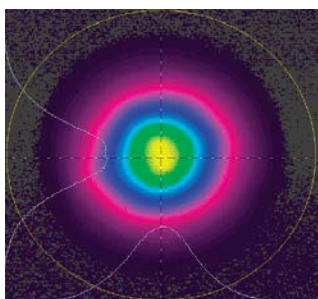

Terra Beam Profile
 Uniform Spatial Profile is optimized
 for Ti:Sapphire pumping

Dimensions

Optical Head (LxWxH)	812 x 254 x 145 mm (31.9 x 10.0 x 5.6 in)
Power Supply (LxWxH)	509 x 483 x 221 mm (20.0 x 19.0 x 8.7 in)
Chiller (LxWxH)	699 x 483 x 492 mm (27.5 x 19.0 x 19.4 in)

Weight

Optical Head	31.5 kg (70 lbs)
Power Supply	27 kg (60 lbs)
Chiller	65 kg (144 lbs)

Electrical Service

Power Supply	Single-phase: 200-240 VAC, 50/60 Hz operating current: 10A, max current: 20A
Chiller	Single-phase: 230 ±10% VAC, 20A, 50/60 Hz operating current: 12A, max current: 20A

Temperature & Humidity

Operating Temperature	15 to 35° C
Storage Temperature	-20C to 50° C
Relative Humidity	8-80%, non-condensing

Control Interface

Serial Interface	RS-232
Rear Connections	External beam enable, external trigger
Control Software	MS Windows-based Laser Commander

Others

Umbilical Length	3.65 m (12.0 ft); longer available upon request
Cooling	Air-water; water-water cooling option available

Terra HP Physical Layout

All dimensions are in inches (mm).

Side View
Power Supply

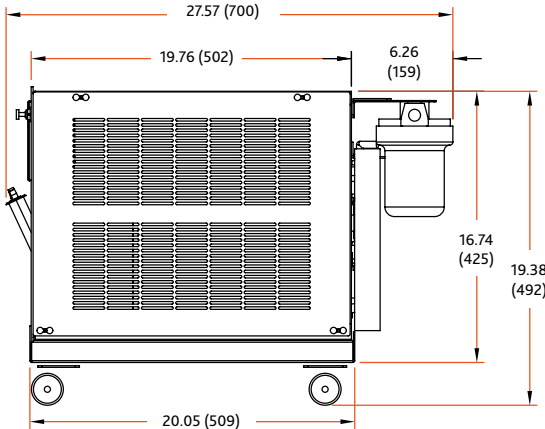
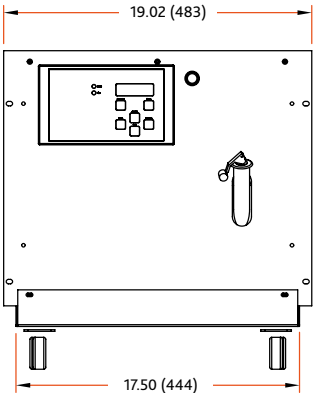
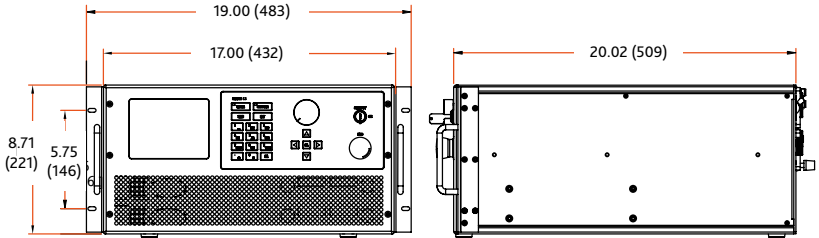

Front View
Chiller

Front View

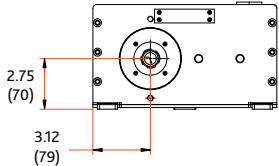

Top View
Optical Head



Side View

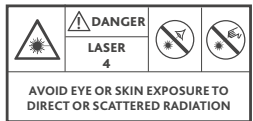
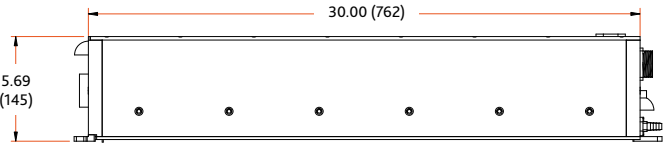

Terra™ HP

Diode pumped Nd:YLF laser

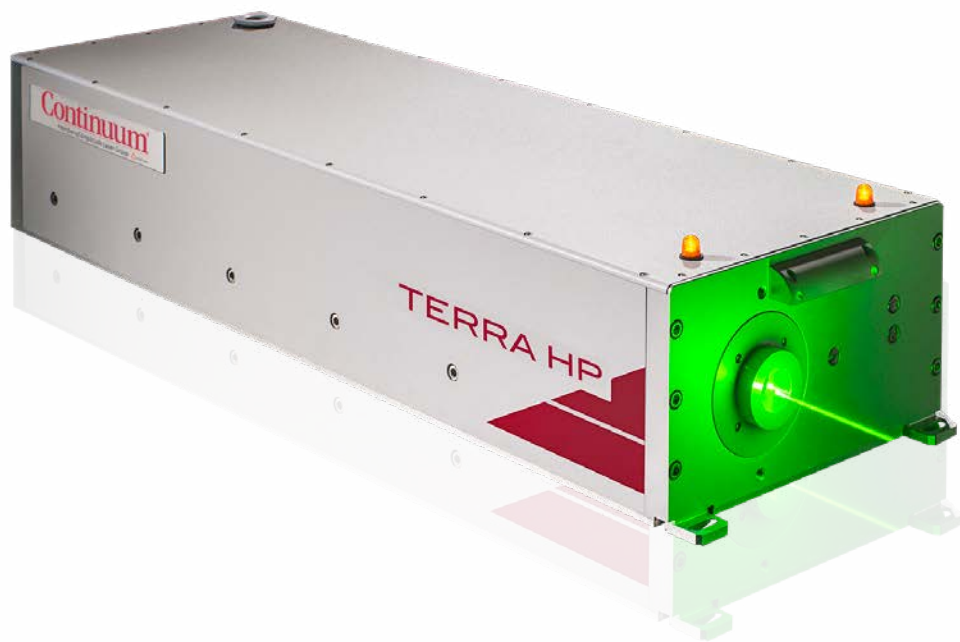

Continuum®
Member of Amplitude Laser Group  Amplitude