

# Mesa™ PIV

## High Power Diode Pumped Nd:YAG Laser

Mesa PIV is a dual oscillator/single head, high repetition rate, diode-pumped Nd:YAG laser. It offers ultimate flexibility for PIV and other dual output applications.

The combination of two oscillators allows complete control of pulse separation and pulse energy. Both oscillators in the Mesa PIV are identical in optical design giving temporally and spatially matched pulses for the highest degree of cross-correlation. Each oscillator can be independently triggered via TTL inputs. As an option, a compact, external combination box can be directly attached to the laser to make access to the beam combination optics easier and safer for the rest of the laser system.

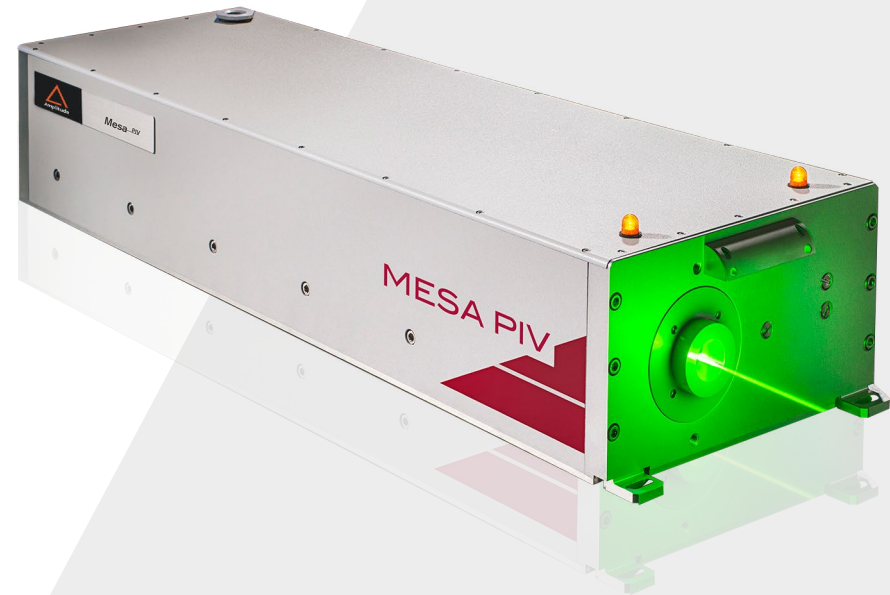

### Applications

#### Industry:

- > Stent/Glass/PCB/Fine Metal Cutting
- > LCD/Solar Edge Deletion
- > Marking
- > Wafer Trimming
- > Micro-hole Drilling
- > Ceramics Scribing
- > Fine Wire Stripping
- > Diamond/Gemstone Processing

#### Science:

- > Ti:Sapphire pumping
- > Particle Image Velocimetry (PIV)
- > Combustion Analysis
- > Laser Induced Fluorescence
- > LIDAR
- > Resonance Raman Spectroscopy
- > Chemical Analysis of Macromolecules
- > Laser Microprobe Analysis

### Key Features

- > 18 mJ total energy at 1-6 kHz
- > 120 W average power at 10 kHz
- > Ideal for Particle Image Velocimetry
- > Independent external trigger for each oscillator
- > Compact & rugged package designed for 24/7 operation
- > Record 3 min. diode module replacement with no realignment necessary
- > Proprietary optical cavity design for optimal beam quality

# Specifications<sup>1</sup>

	532-120-M	532-80-M	532-80-L	532-60-M
Wavelength	532			
Power (W) @ 10 kHz	120	80		60
Energy per Osc (mJ) at 1- 6 kHz	9	6.5		5
Total Pulse Energy (mJ) at 1-6kHz	18	13		10
Repetition Rate (kHz) <sup>1</sup>	1-30			
Pulse-to-Pulse Stability (% RMS)	< 2		< 3	< 2
Pulsewidth (ns)	< 150	< 170	< 150	< 190
Beam Pointing Stability (μrad RMS)	< 20			
Beam Diameter (mm) <sup>3</sup>	5		3	5
Beam Divergence (mrad) <sup>4</sup>	7		5	7
Beam Quality (M <sup>2</sup> )	< 25		< 15	< 25
Polarization <sup>5</sup>	Circular			

<sup>1</sup> All specifications at 6 kHz unless otherwise noted  
<sup>2</sup> Single shot to 1 kHz available with external trigger.  
<sup>3</sup> Measured at 13.5% level at output window  
<sup>4</sup> Typical measurement (±10%).  
<sup>5</sup> Cross-polarization available as option.

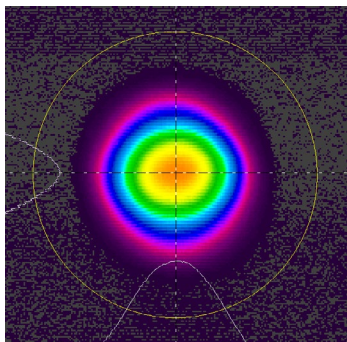

Mesa PIV 532-120-M Beam Profile

## Dimensions

Optical Head (LxWxH)	812 x 254 x 145 mm (31.9 x 10.0 x 5.6 in)
Power Supply (LxWxH)	509 x 483 x 221 mm (20.0 x 19.0 x 8.7 in)
Chiller (LxWxH)	699 x 483 x 492 mm (27.5 x 19.0 x 19.4 in)

## Weight

Optical Head	31.5 kg (70 lbs)
Power Supply	27 kg (60 lbs)
Chiller	65 kg (144 lbs)

## Electrical Service

Power Supply	Single-phase: 200-240 VAC, 50/60 Hz operating current: 10A, max current: 20A
Chiller	Single-phase: 230 ±10% VAC, 50/60 Hz operating current: 12A, max current: 20A

## Temperature & Humidity

Operating Temperature	15 to 35° C
Storage Temperature	-20C to 50° C
Relative Humidity	8-80%, non-condensing

## Control Interface

User Interface	Full featured front panel control
Serial Interface	RS-232
Rear Connections	External beam enable, external trigger
Control Software	MS Windows-based Laser Commander™

## Others

Umbilical Length	3.65 m (12.0 ft); longer available upon request
Cooling	Air-water; water-water cooling option available

# Mesa PIV Physical Layout

All dimensions are in inches (mm).

Top View  
Optical Head

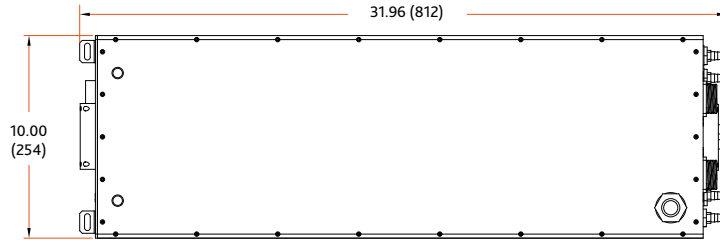

Front View

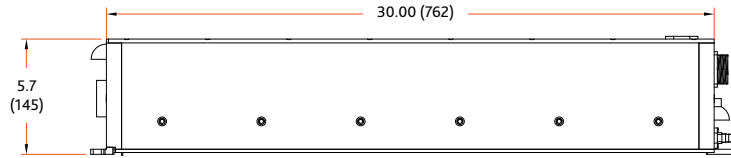
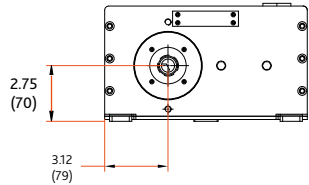

Side View

Side View  
Power Supply

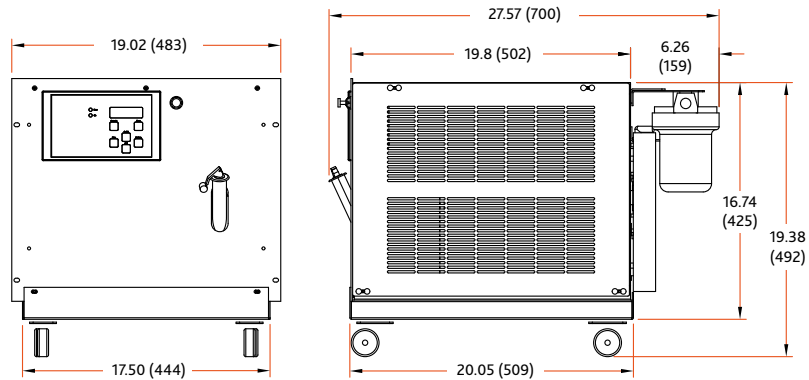
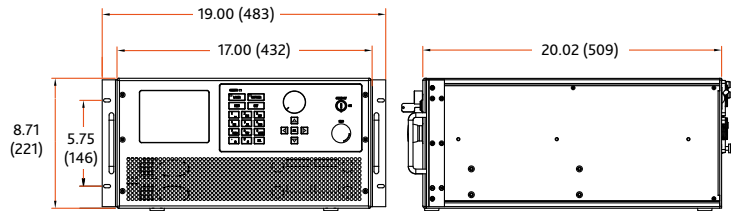

Front View  
Chiller

## Advantages

Generation of Pulse Pairs

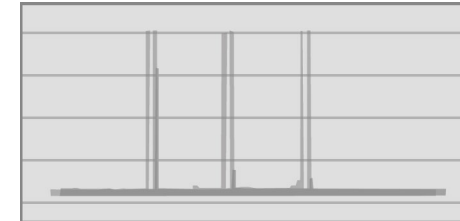

Generation of Pulse Pairs  
Flexible time delay adjustment

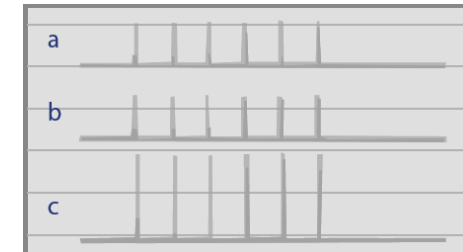

Two laser output synchronized to double the pulse energy and peak power,  
a) one laser output,  
b) a second laser output, and  
c) combined output.

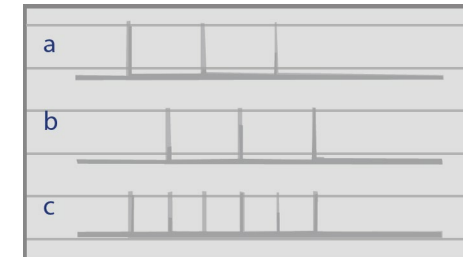

Two laser output combined with an adjustable delay to double the repetition rate of the pulse.  
a) one laser output,  
b) a second laser output with delay, and  
c) combined laser output.

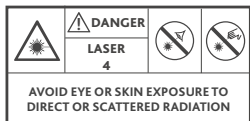

# Mesa™ PIV

*Diode pumped Nd:YAG laser*

