

Terra™

Diode pumped Nd:YLF laser

The Terra Nd:YLF laser is the smallest laser in its class. It produces high average power (>50 W) at kilohertz repetition rates. Our proprietary intracavity frequency doubling results in high conversion efficiency, without resorting to the tight focusing in the doubling crystal, which is normally necessary in an extracavity design and leads to possible optical damage. Our proprietary pump chamber design further increases the system's overall efficiency.

High pulse energy, smallest M^2 , and small jitter are all available in this extremely compact and highly ruggedized package, optimized for pumping Ti:Sapphire amplifiers

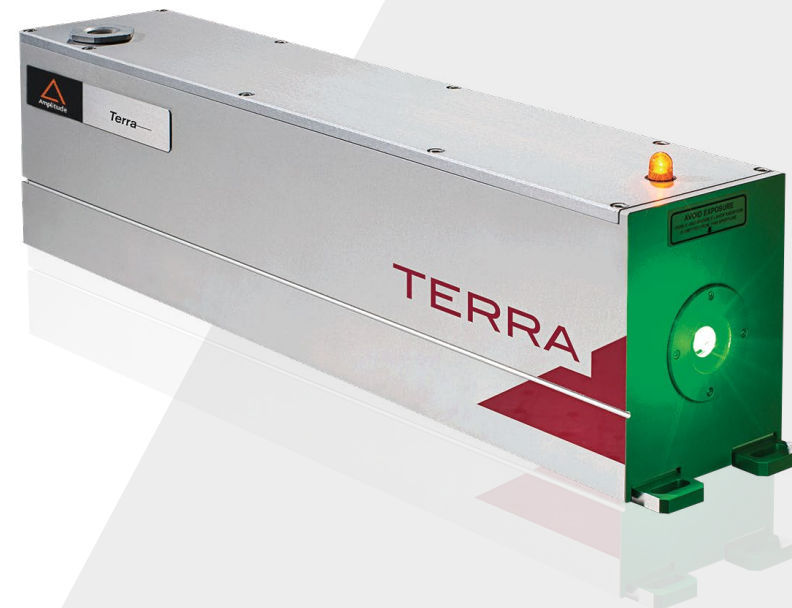

Applications

Industry:

- > Stent/Glass/PCB/Fine Metal Cutting
- > LCD/Solar Edge Deletion
- > Marking
- > Wafer Trimming
- > Micro-hole Drilling
- > Ceramics Scribing
- > Fine Wire Stripping
- > Diamond/Gemstone Processing

Science:

- > Ti:Sapphire pumping
- > Particle Image Velocimetry (PIV)
- > Combustion Analysis
- > Laser Induced Fluorescence
- > LIDAR
- > Resonance Raman Spectroscopy
- > Chemical Analysis of Macromolecules
- > Laser Microprobe Analysis

Key Features

- > >30 mJ pulse energy at 1kHz
- > Average power >50 W @ 3 kHz
- > Repetition rates up to 10 kHz
- > Exceptional beam pointing and power stability
- > Compact, rugged & hermetically sealed laser head
- > Quick & easy diode module replacement (3min)
- > Proprietary pump chamber design for optimal beam quality
- > Optimized for ultrafast amplifier pumping

Specifications¹

	527-50-M	527-40-M	527-30-M	527-20-M
Transverse Mode	MM			
Pulse Energy at 0.1-1 kHz (mJ)	30	25	20	15
Pulse Repetition Rate (kHz) ²	0.1-10			
Average Power @ 3 kHz (W)	50	40	30	20
Pulsewidth (ns)	< 140	< 150	< 160	< 170
Energy Stability (% rms)	< 0.5			
Beam Pointing Stability (μrad)	< 25			
Beam Diameter at Output (mm) ^{3,4}	2.5			
Beam Quality (M ²)	< 12			
Beam Divergence (mrad) ³	8			
Time Jitter (ns rms)	< 3			
Polarization (Vertical/Horizontal)	Horizontal			

¹ All specifications at 1kHz unless otherwise noted.
² Single shot to 0.1 kHz available with external trigger
³ Typical measurement (±10%)
⁴ Measured at 13.5% level at output window

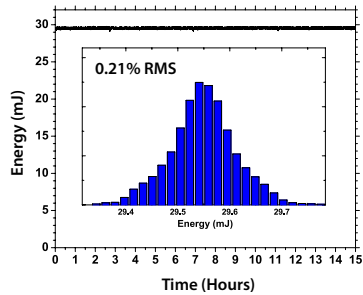

Terra Energy Stability - Terra-527-40-M output energy stability measurement

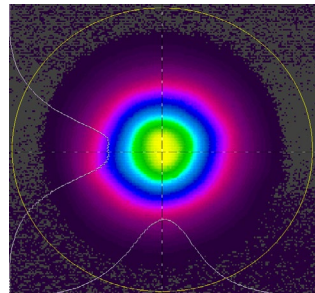

Terra Beam Profile - Uniform Spatial Profile is optimized for Ti:Sapphire pumping

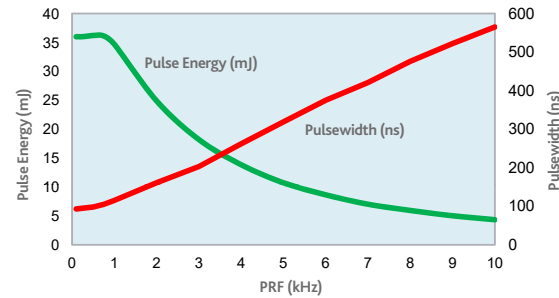

Laser System Output Characteristics
Terra 527-50-M Performance Curves

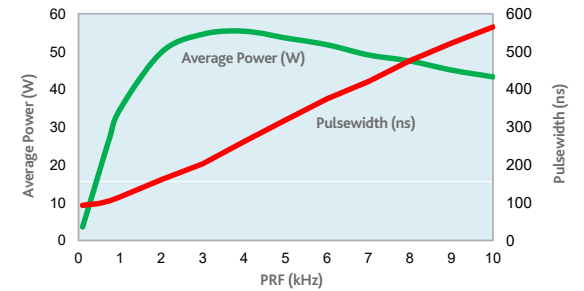

Terra Physical Layout

All dimensions are in inches [mm].

Side View

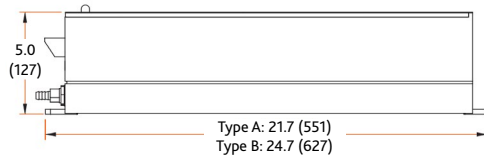

Front View

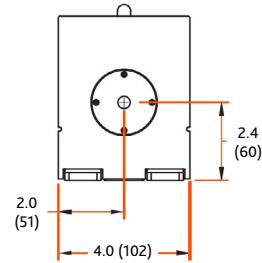

Front View Power Supply

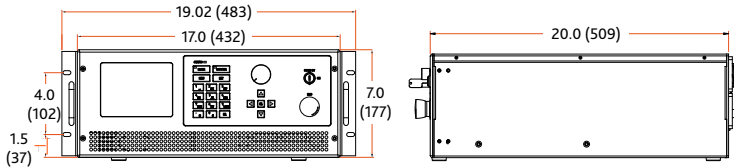

Side View

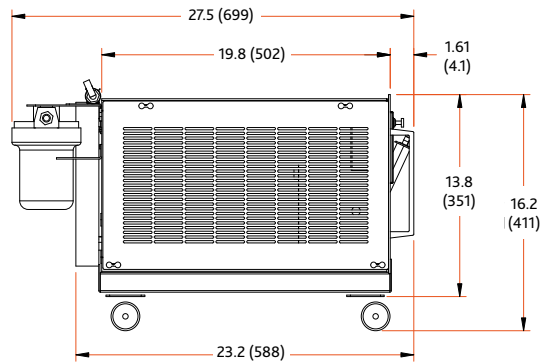
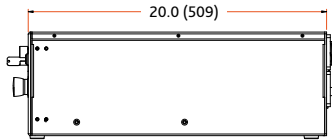

Side View

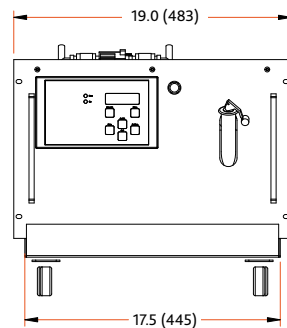

Front View Chiller

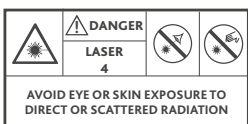

Dimensions

Optical Head (LxWxH)	A) 551 x 102 x 127 mm (21.7 x 4.0 x 5.0 in) mm models; B) 627 x 102 x 127 mm (24.7 x 4.0 x 5.0 in) TEM ⁰⁰ mode
Power Supply (LxWxH)	509 x 483 x 177 mm (20.0 x 19.0 x 7.0 in)
Chiller (LxWxH)	699 x 483 x 411 mm (27.5 x 19.0 x 16.2 in)

Weight

Optical Head	A) 9 kg (20 lbs) / B) 10.5 kg (23 lbs)
Power Supply	17.7 kg (39 lbs)
Chiller	55 kg (122 lbs)

Electrical Service

Power Supply	Single-phase: 200-240 VAC, 50/60 Hz operating current: 5A, max current: 10A
Chiller	Single-phase: 230 ±10% VAC, 50/60 Hz operating current: 10A, max current: 15A

Temperature & Humidity

Operating Temperature	15 to 35° C
Storage Temperature	-20C to 50° C
Relative Humidity	8-80%, non-condensing

Control Interface

Serial Interface	RS-232
Rear Connections	External beam enable, external trigger
Control Software	MS Windows-based Laser Commander

Umbilical Length

	3.65 m (12.0 ft)
--	------------------

Cooling

	Air-water; water-water cooling option available
--	---

Terra

Diode pumped Nd:YLF laser

